

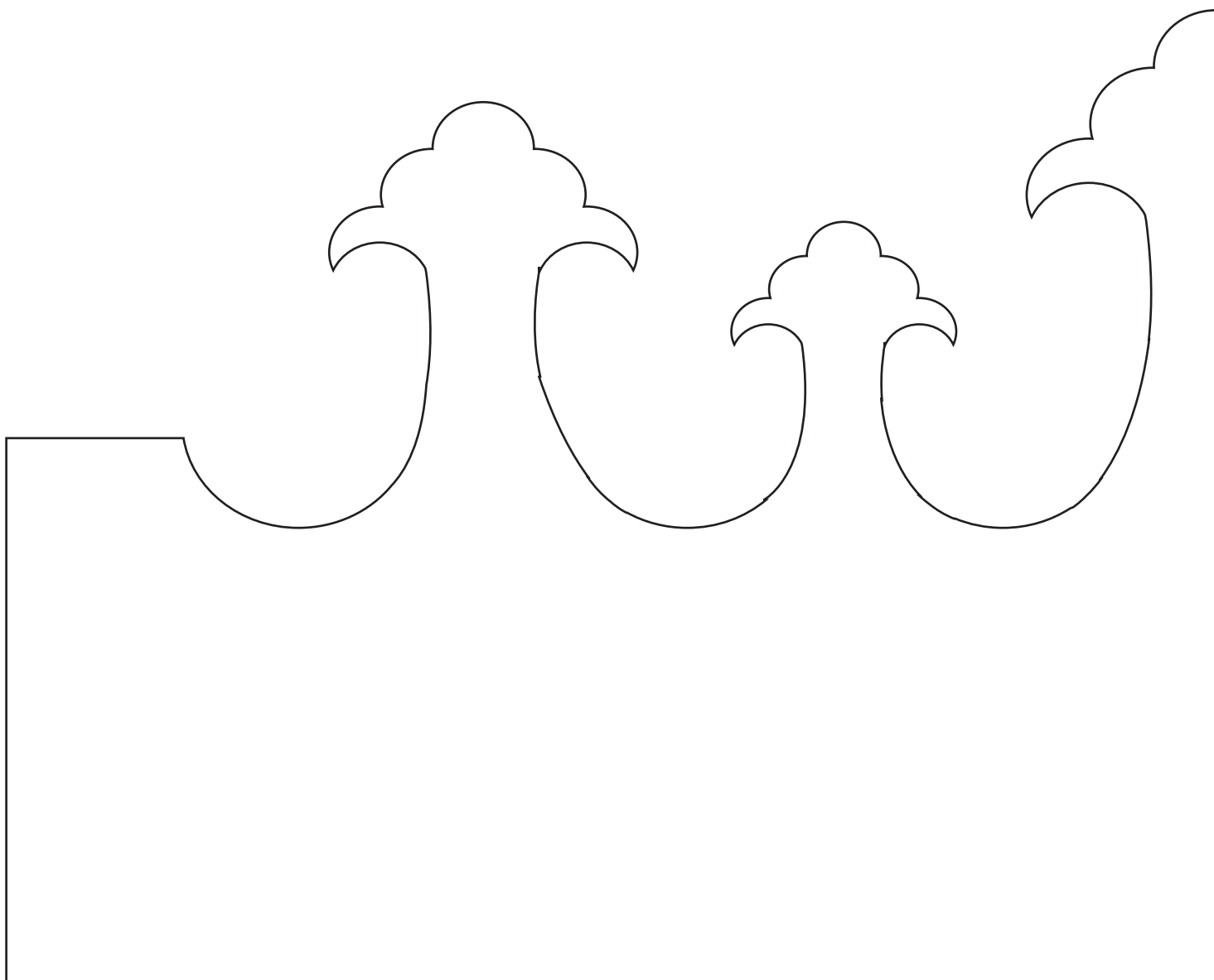

ENGLISH HERITAGE

HENRY II'S CROWN ASSEMBLY INSTRUCTIONS

Print and cut out this crown template, then either draw round it onto card or stick it onto card. Score and fold along the dotted lines. Cut out the two pieces and join them together, then add an extra strip of card at the back to make it the right size for your head.



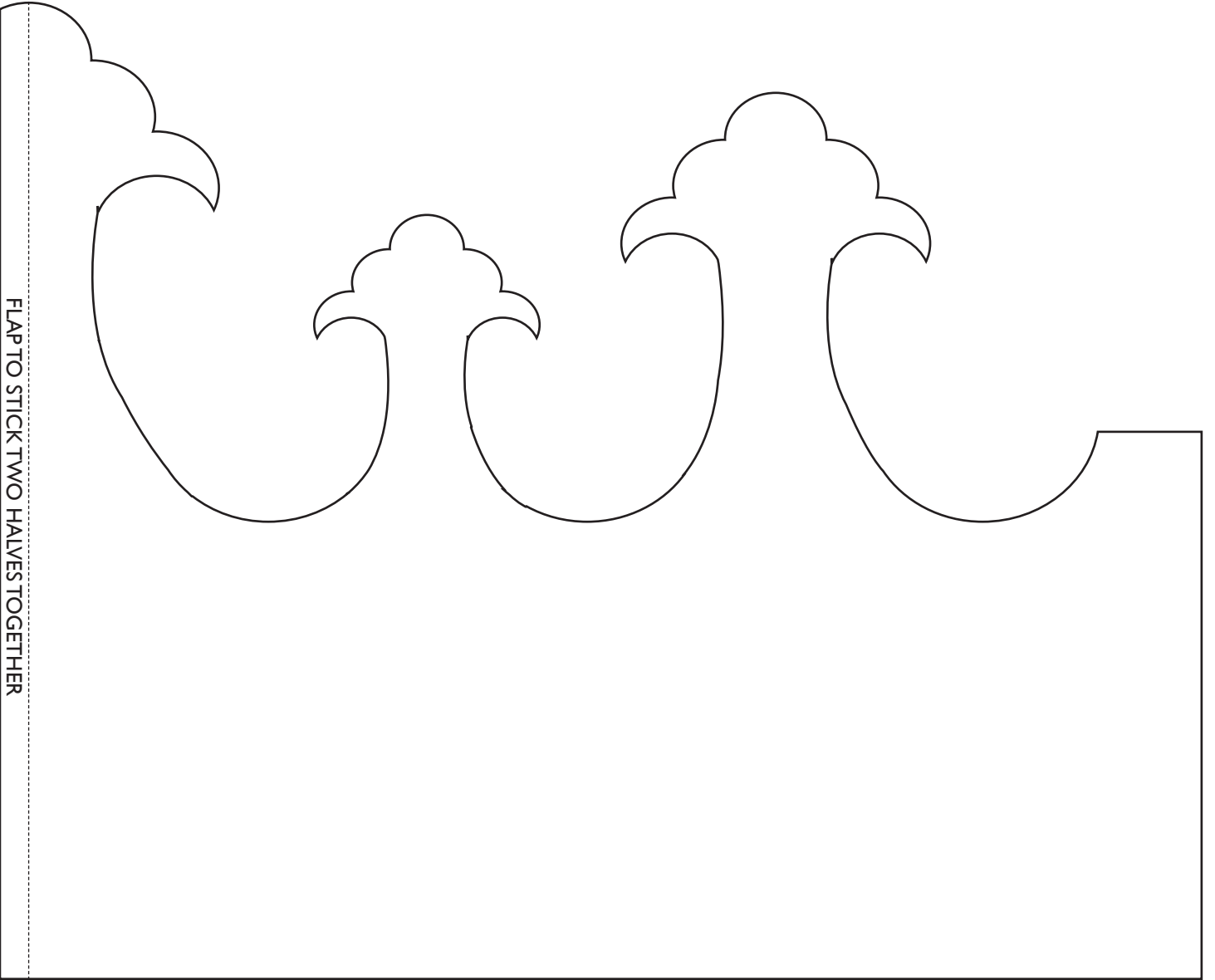

FLAP TO STICK TWO HALVES TOGETHER



ENGLISH HERITAGE

ST EDWARD'S CROWN ASSEMBLY INSTRUCTIONS

Print and cut out the templates on these two pages plus the four templates on the following two pages. Either draw round them onto card or stick them onto card. Cut them out. Score and fold along the dotted lines. Join the two main crown pieces together, then add an extra strip of card at the back to make it the right size for your head. Stick the two long pieces at right angles across the top of the crown to make an x shape, then attach the two ball and cross shapes to the centre of the top long piece.

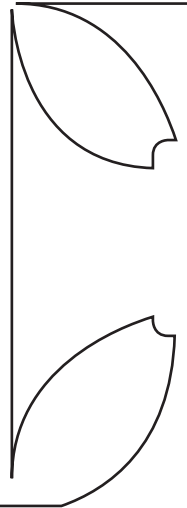
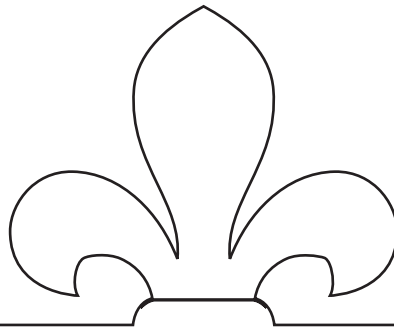
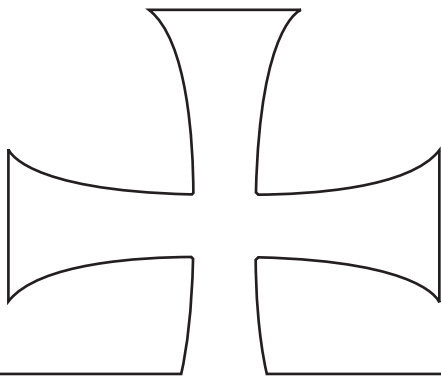

FLAP TO STICK TWO HALVES TOGETHER

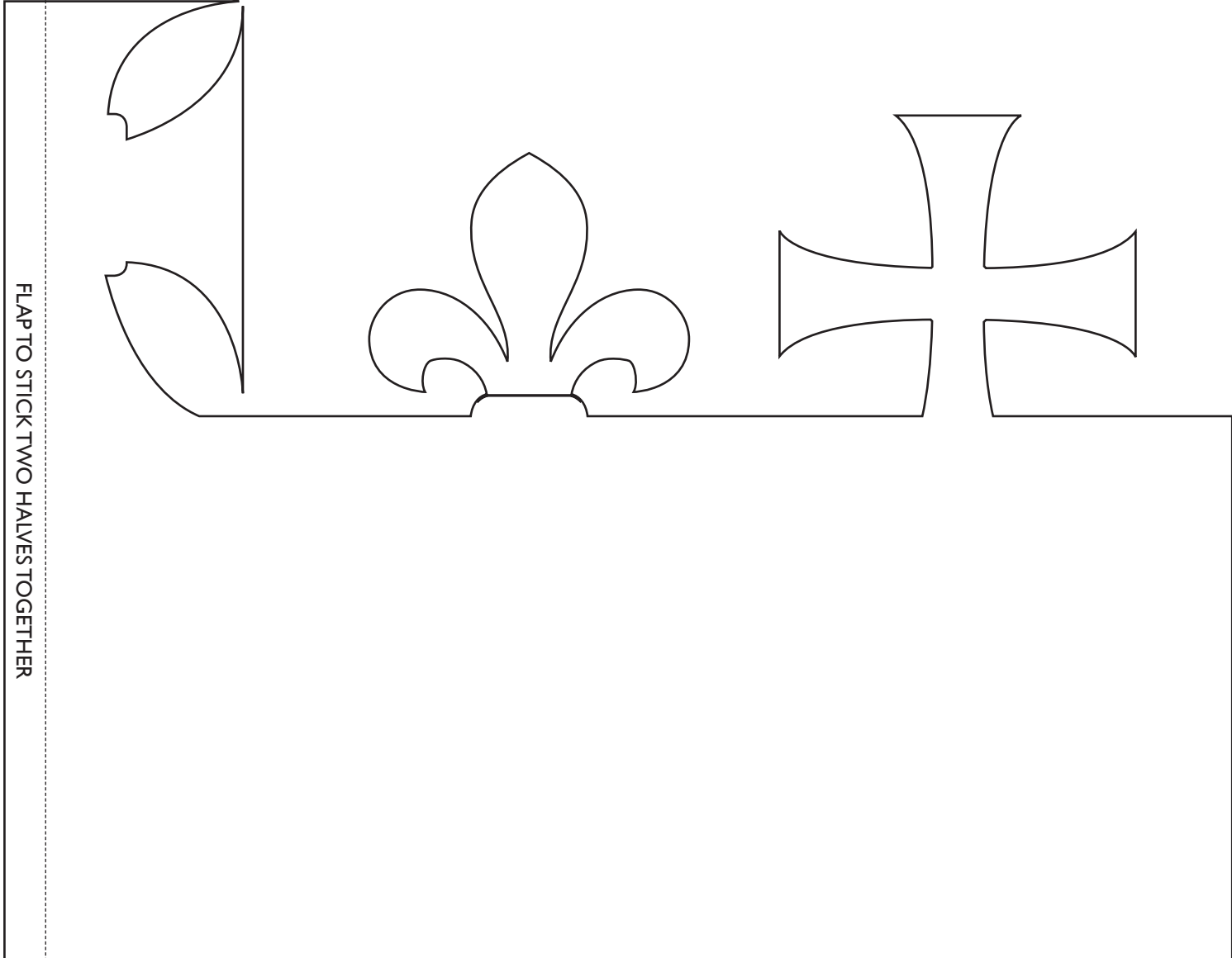
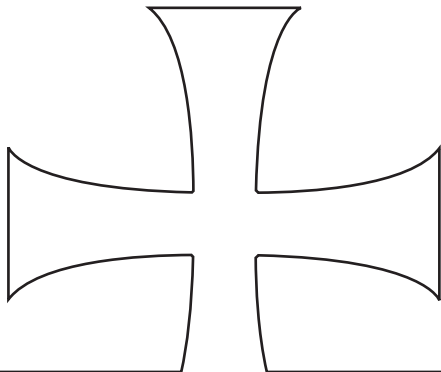
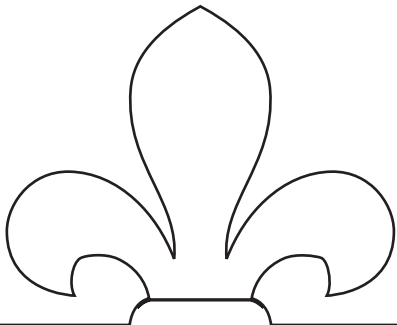
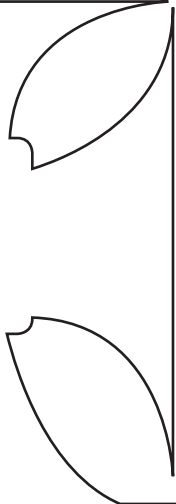



ENGLISH HERITAGE

ST EDWARD'S CROWN

--

--

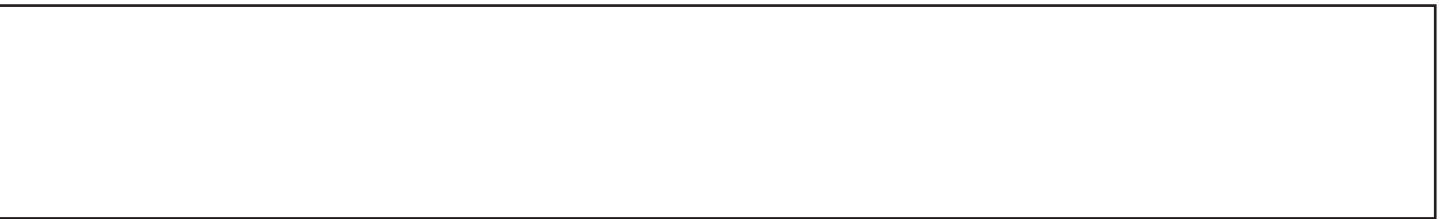
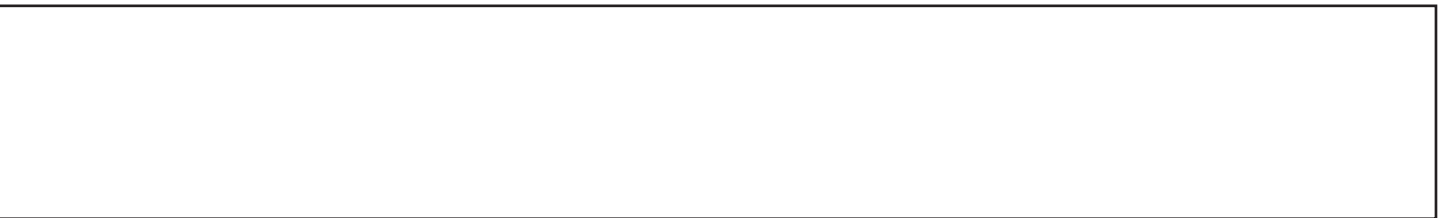
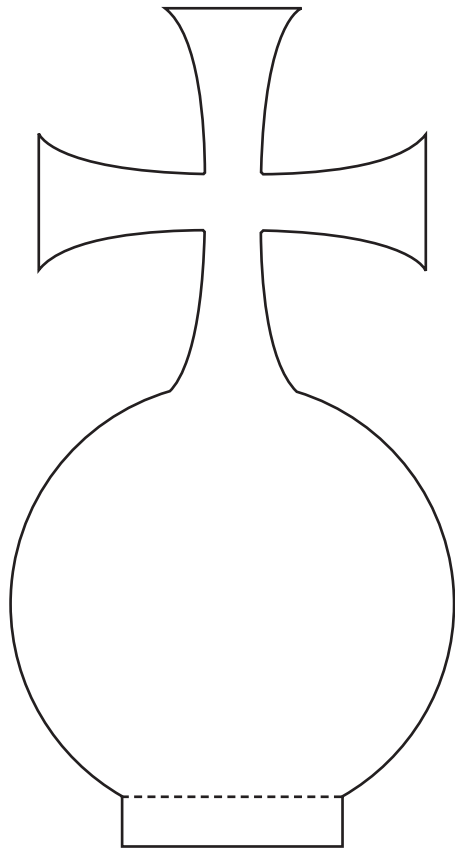
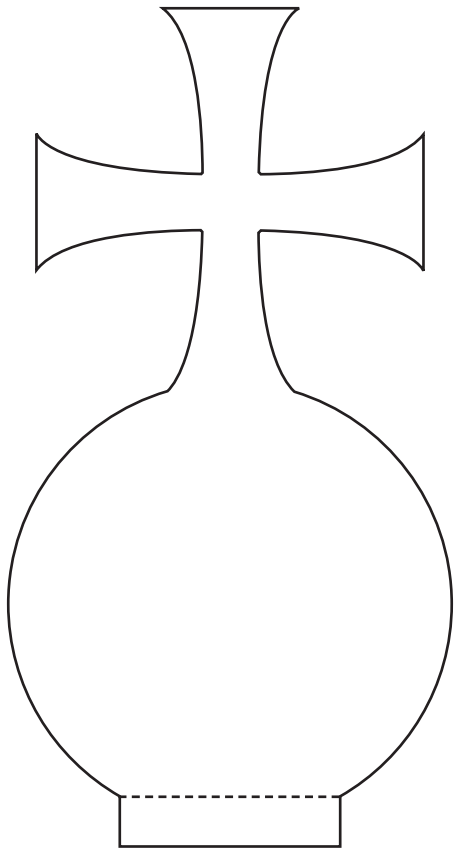



ENGLISH HERITAGE

THE IMPERIAL STATE CROWN ASSEMBLY INSTRUCTIONS

Print and cut out the templates on these two pages plus the four templates on the following two pages. Either draw round them onto card or stick them onto card. Cut them out. Score and fold along the dotted lines. Join the two main crown pieces together, then add an extra strip of card at the back to make it the right size for your head. Stick the two long pieces across the top of the crown at right angles to make an x shape, then attach the two ball and cross shapes to the centre of the top long piece.

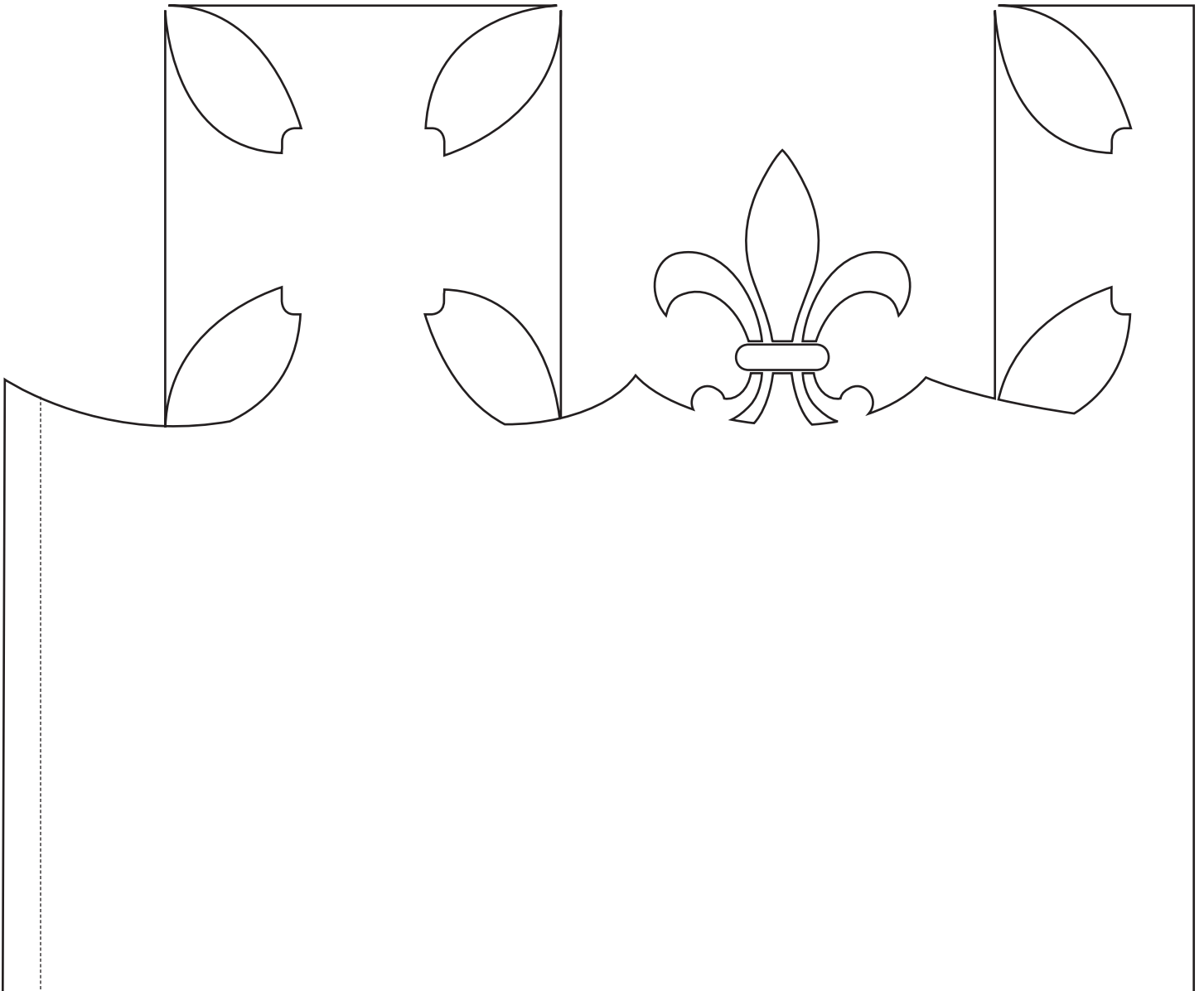

FLAP TO STICK TWO HALVES TOGETHER

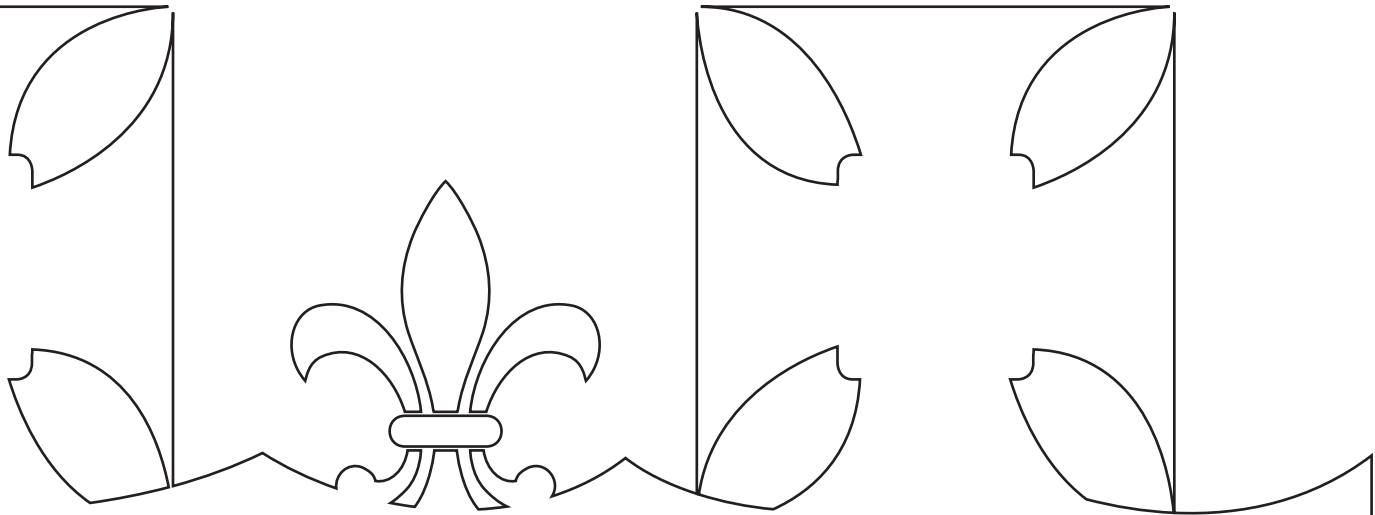

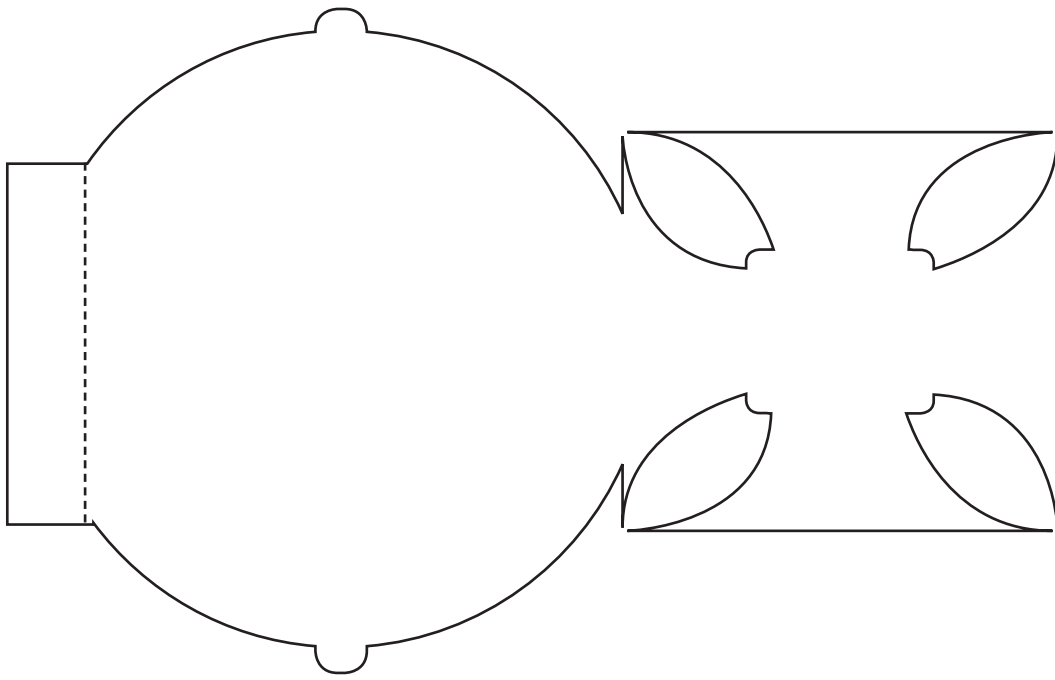

ENGLISH HERITAGE

THE IMPERIAL STATE CROWN

